

This enclosure is meant for a SINGLE (1) RAP 10" 4th Order Band-Pass

Specs: 0.7 cuft net Sealed to 0.4 cuft net Ported Tuned to 73 Hz
Exterior Dimensions: 12"H x 15.479"D x 20"W
Interior Separation: W1 Sealed Side:10.309" W2 Ported Side: 9.691"
Port Specs: 10.5"H x 1.5"W x 16.477"L

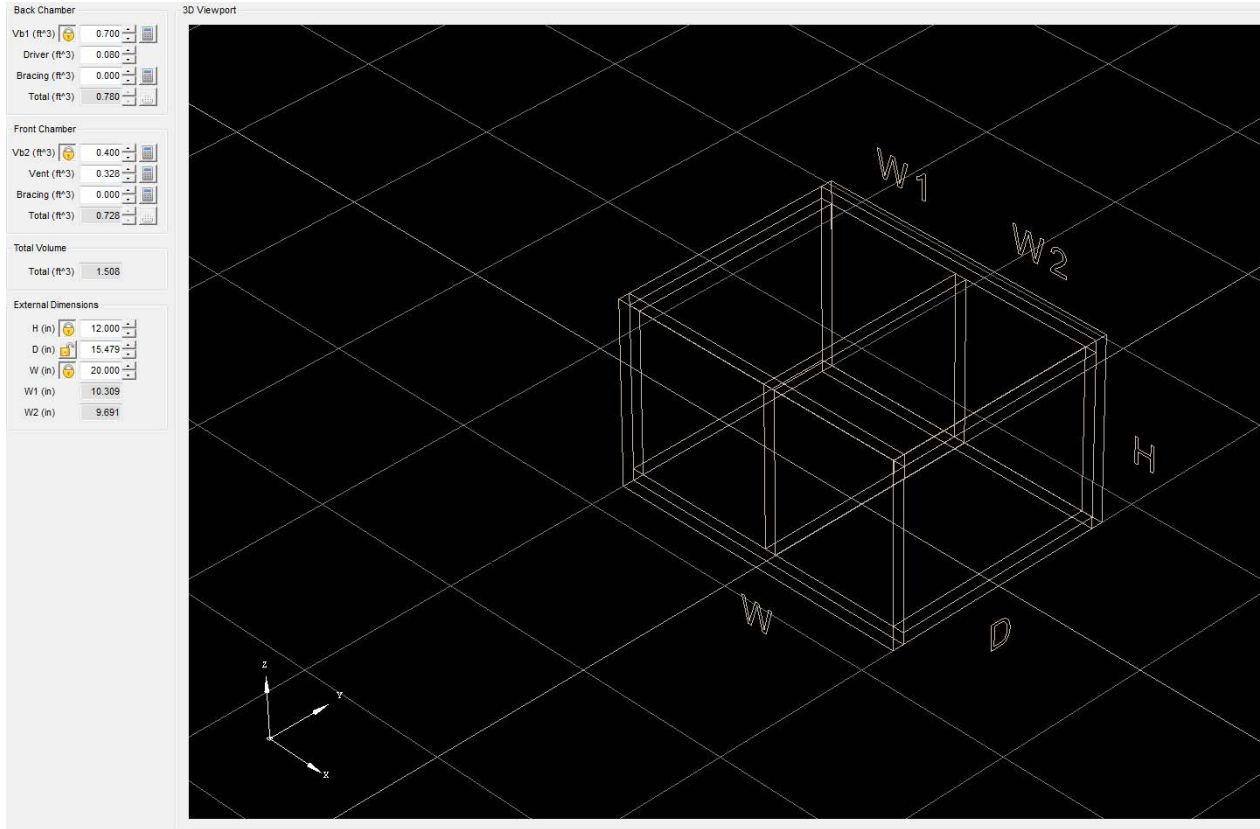

Port

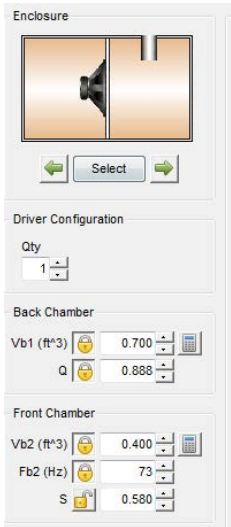
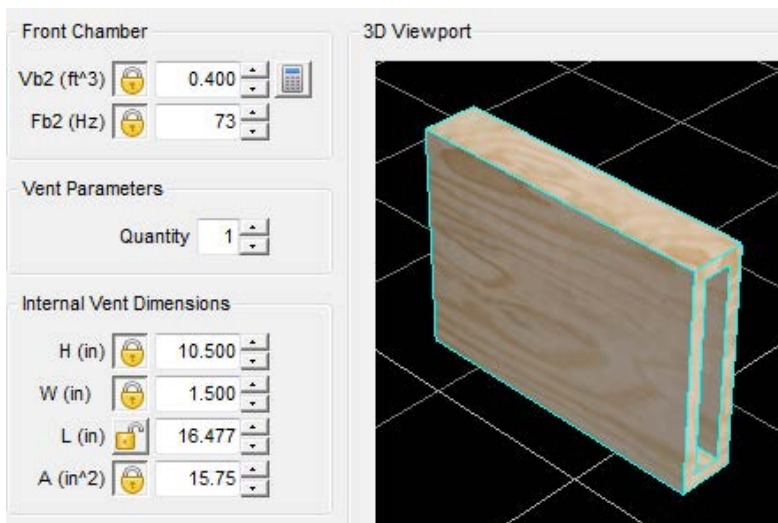

Panel Cut Sheets

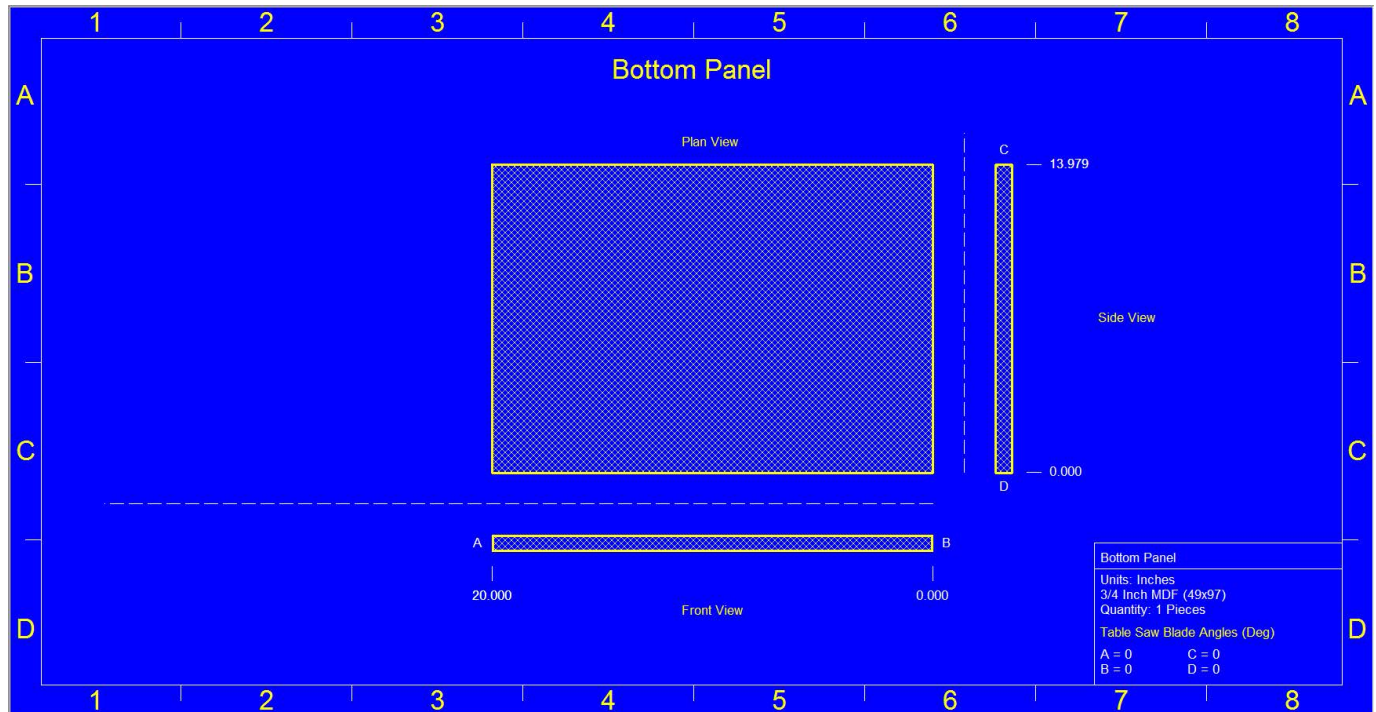
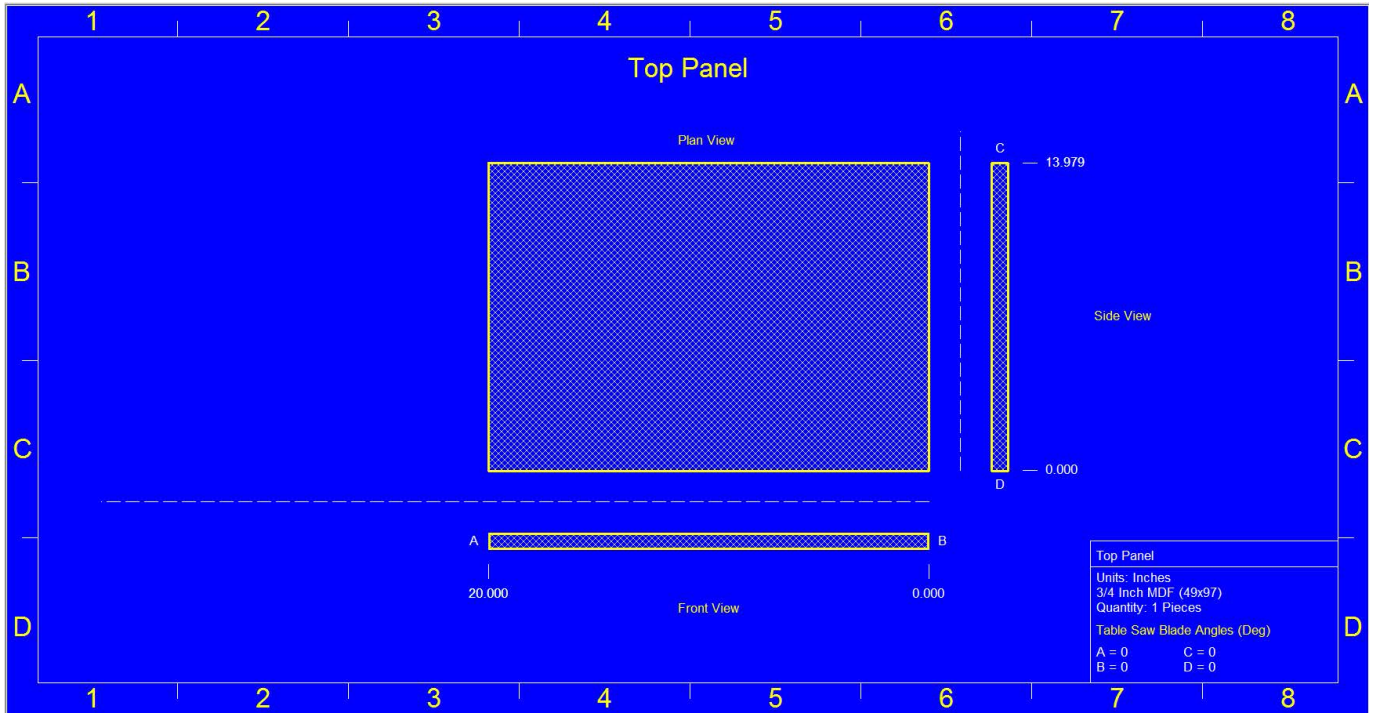

Panel Cut Sheets

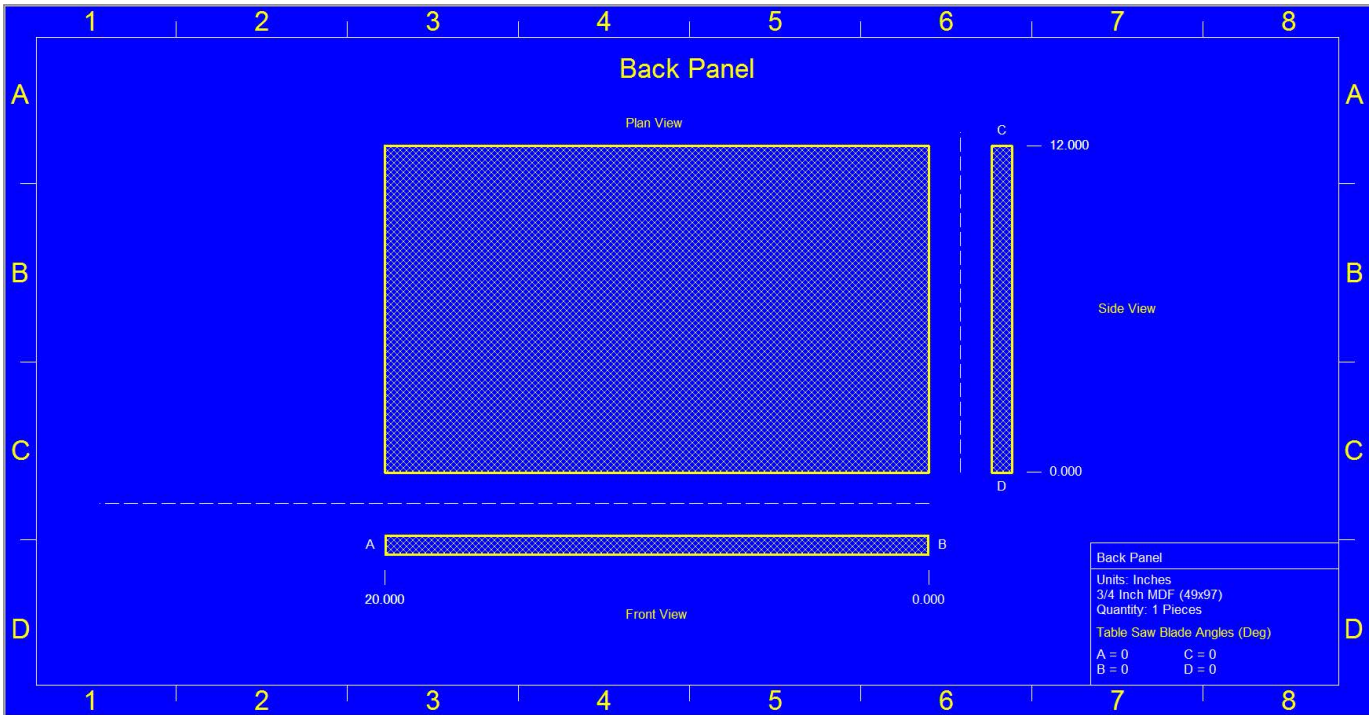
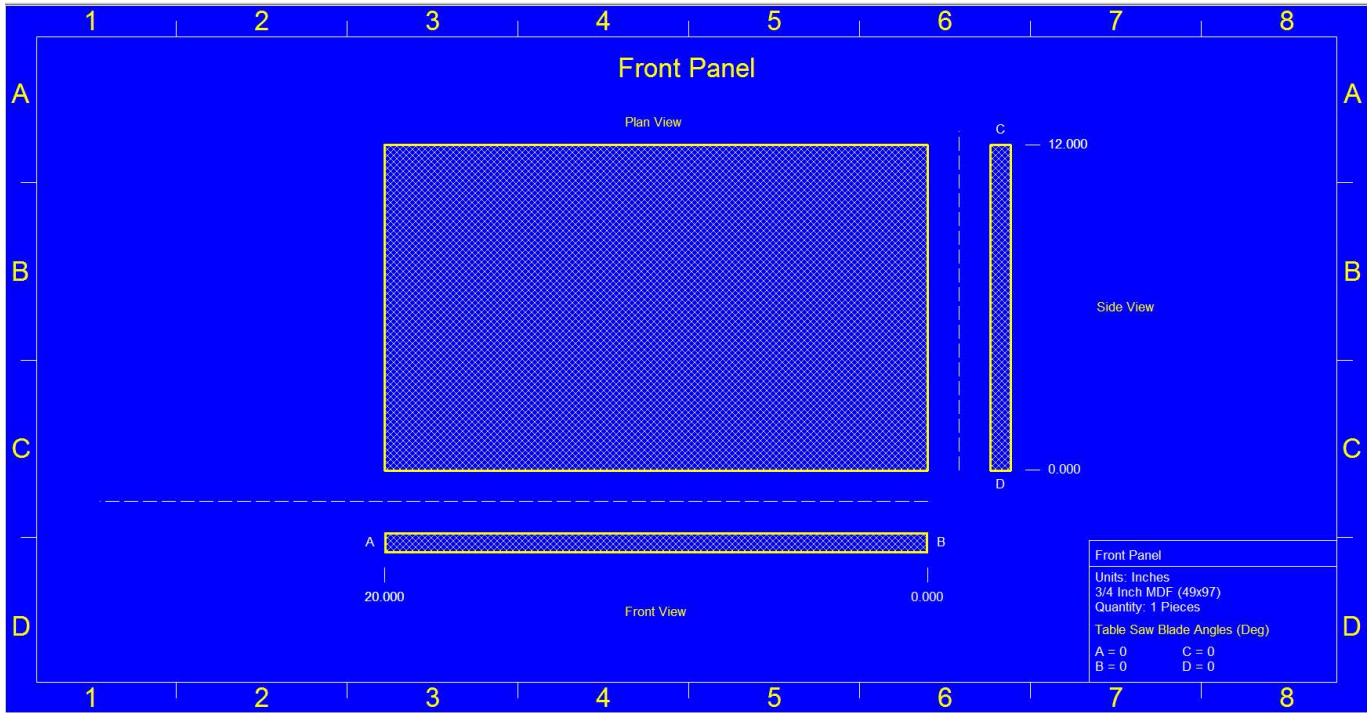

Panel Cut Sheets

